

## 8. Install and Use Included Software

### Installing the Software

1. Insert the included software CD.
2. WINDOWS: The install window should appear. If not, double-click the file "launch.exe".  
MACINTOSH: Double-click the CD-ROM icon on your desktop.
3. Follow the instructions on the screens.

The following software is included. Refer to Help for each software application.

**KODAK PROFESSIONAL DCS Camera Manager**  
Use to capture images when your camera is connected to a computer.

**KODAK PROFESSIONAL DCS Photo Desk**  
Lets you open Raw images, perform DCS-specific image edits, then save the images in a variety of formats.

**KODAK PROFESSIONAL Extended Range Imaging File Format Module**  
Lets you open ERI JPEG images directly into ADOBE Photoshop while reconstructing the extended dynamic range/color gamut and allowing you to perform DCS-specific image edits.

**KODAK PROFESSIONAL DCS File Format Module**  
Lets you open Raw images directly into ADOBE Photoshop and other compatible software.

## Tips

### IEEE 1394 Communications Setup

- Be sure the orientation is correct when you connect the IEEE 1394 cable to the computer. Connecting incorrectly can damage your camera or computer. The point on the 6-pin plug must align with the point on the computer.
- Do not use repeaters or cables exceeding 10 meters (10.9 yards). Doing so can damage your camera or degrade performance.

## Tips - continued

### Memory Card Management

- Format your memory card in your camera before taking pictures. This lets you use the Recover feature to recover images that have not been deleted and overwritten.
- Consider saving your Raw images when performing in-camera processing. The Raw image may allow you to change resolution based on output needs and perform image edits. (See the User's Guide for saving Raw images in Advanced mode.)

### Battery Management

- To maximize your battery life, use the battery until it is low before recharging. (The battery icon blinks on the Top Status LCD when the battery is low.)
- Do not leave the battery in your camera when it is not in use. When the camera is turned off, there is a small drain of battery power.

### Lenses

- Take special care attaching your lenses to your camera. Do not force.
- Do not use incompatible lenses. See the User's Guide.

### Strobes/Flash Units

- Only use flash units recommended for use with your camera.
- Use of a radio slave for strobes is highly recommended to isolate your camera's flash circuitry from the high-powered circuitry of your strobes.
- Use strobes with a trigger voltage less than 250 volts. Failure to do so could result in inconsistent firing of the strobes or damage to your camera's circuitry.
- Use of a safe sync is recommended. It isolates your camera's flash circuitry from the high-powered circuitry of your strobes.

 EASTMAN KODAK COMPANY  
Rochester, NY 14650 U.S.A.  
www.kodak.com/go/dcs  
© Eastman Kodak Company, 2004  
TM: Kodak, Kodak Professional

# Kodak Professional DCS ProSLR/n DIGITAL CAMERA

## QUICK START GUIDE



688984

## Front/Side/Top

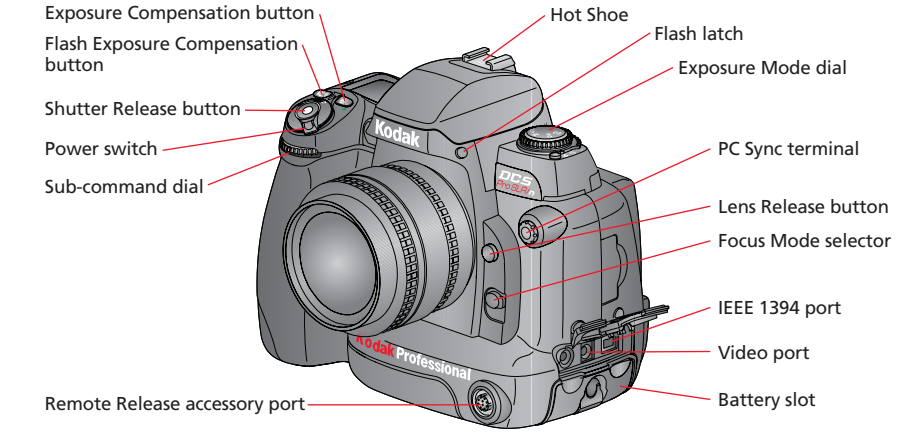

### Digital Status LCD

Quickly access digital functions using Digital Status button and Four-way switch.

Provides information as you review images.

### Top Status LCD

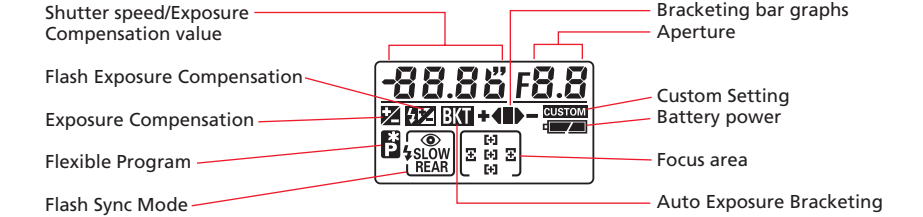

## Back/Side/Bottom

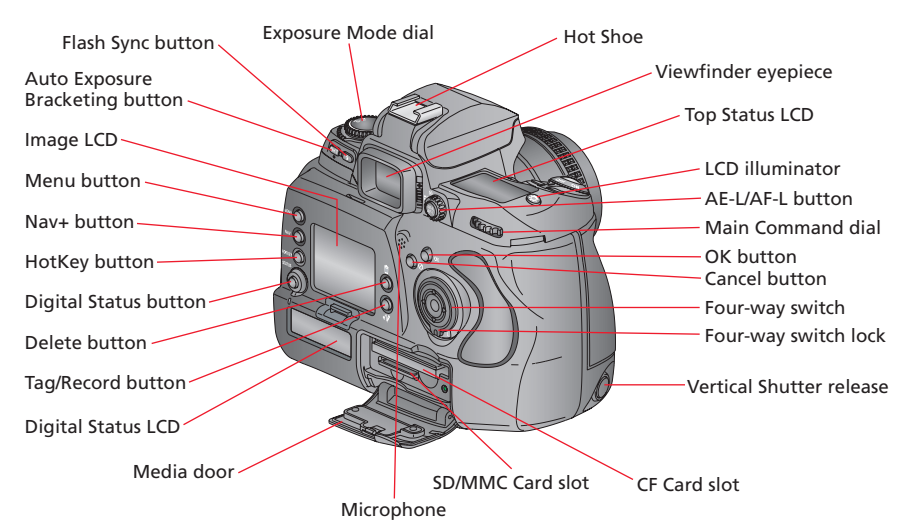

### Viewfinder

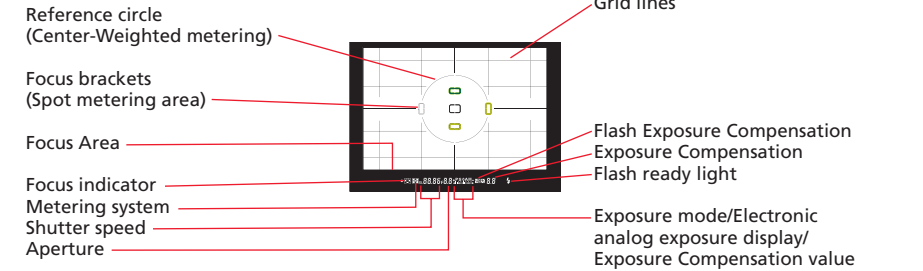

## 1. Power Your Camera

### Using the KODAK PROFESSIONAL DCS Pro Battery

1. Charge battery, if needed, by plugging in the KODAK PROFESSIONAL DCS Pro Charger/AC Adapter and inserting the battery.

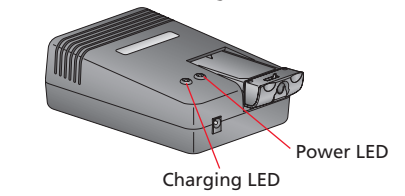
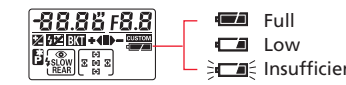

2. Insert the charged battery into the battery slot on the camera and turn the latch clockwise.

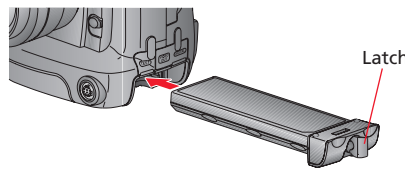

### Using the KODAK PROFESSIONAL DCS Pro DC Power Module

1. Insert the power module into the battery slot on the camera and turn the latch clockwise.
2. Connect the DC cable to the power module and Charger/AC Adapter.
3. Plug in the Charger/AC Adapter.

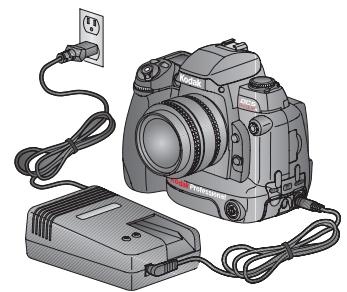

## 2. Mount the Lens

1. Turn off the camera.
2. Mount the lens to the camera body.
3. Set the lens to its minimum aperture (highest F-stop number).
4. Lock the lens.

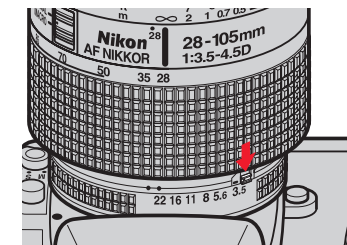
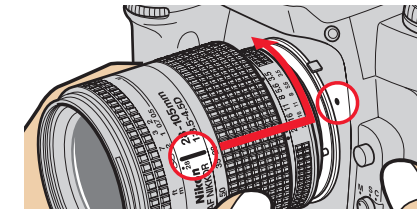

## 3. Prepare the Memory Cards

Your camera has slots for two memory cards: a COMPACTFLASH (CF) card and a SECURE DIGITAL (SD) card or MultiMedia (MMC) card. See the User's Guide.

### Inserting a Card

1. Open the Media door.
2. If using a CF card, insert it in the top slot, label side down.  
If using an SD or MMC card, insert it in the bottom slot, label side down.  
With two cards, insert either card first.
3. Close the Media door.

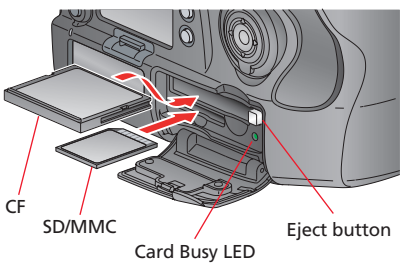

### Formatting a Card

If you have not previously used the card in your camera, you may want to format it so that you can use the camera's Recover feature. See the User's Guide.

1. Choose Format Card from the Basic menu (page 8), then choose CF Card or MM Card.
2. Press the OK button.



### Removing a Card

1. Open the Media door.
2. To remove a CF card, press the Eject button. To remove an SD or MMC card, press and release the end of the card. If removing two cards, remove either card first.
3. Close the Media door.

## 4. Choose Camera Settings

### Setting Focus

1. Set the Focus Mode selector to S (Single Servo AF).
2. Set the Exposure Mode dial to AF Area Mode.
3. Turn the Main Command dial until [ ] (Single Area AF) appears in the Top Status LCD.
4. Lightly press the Shutter Release button, and press any side of the Four-way switch to choose the center focus area.

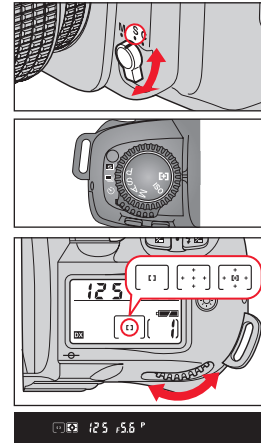

### Setting the Metering System and Exposure Mode

1. Set the Metering System selector to (Matrix Metering). The Matrix Metering symbol appears in the viewfinder.
2. Set the Exposure Mode dial to P (Programmed Auto).

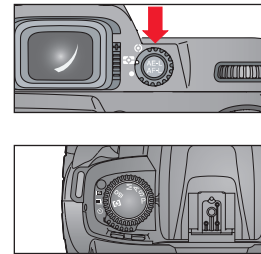

## 5. Choose Digital Settings

The Basic Mode menu is shown here. See the User's Guide for Advanced Mode. Advanced Mode provides additional choices such as 2 memory cards, JPEG quality, and the ability to save Raw images.

### Using the Basic Menu

1. Press the Menu button to display the Basic Mode menu on the Image LCD.
2. Press the top or bottom of the Four-way switch to highlight a menu option.
3. Press the right of the Four-way switch to display and enable a pop-up menu, then press the top or bottom of the Four-way switch to highlight a menu option.
4. Press the OK button.

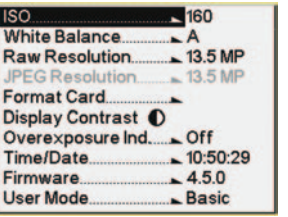

### Setting Resolution

You can set JPEG or Raw resolution:

Resolution	Size	JPEG	Raw
13.5 MP	Full-resolution images (4500 x 3000)	X	X
6.0 MP	Half-resolution images (3000 x 2000)	X	X
3.4 MP	Quarter-resolution images (2250 x 1500)	X	X
0.8 MP	0.8-resolution JPEG images (1125 x 750)	X	

Choose Raw Resolution or JPEG Resolution from the Basic menu, then highlight a resolution.

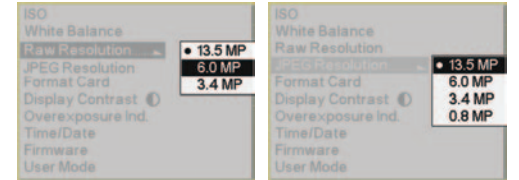

## 5. Choose Digital Settings - continued

### Setting ISO

- Choose ISO from the Basic menu then highlight the desired setting.

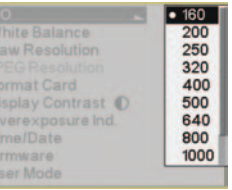

## 6. Focus and Capture an Image

1. Center the focus brackets on your subject and lightly press the Shutter Release button.  
  
The camera focuses automatically. If • appears in the viewfinder, the subject is in focus.
2. Slowly depress the Shutter Release button to capture the image.

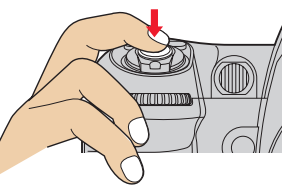

## 7. Review Images on the Camera

You can review images on the Image LCD in four Image modes:

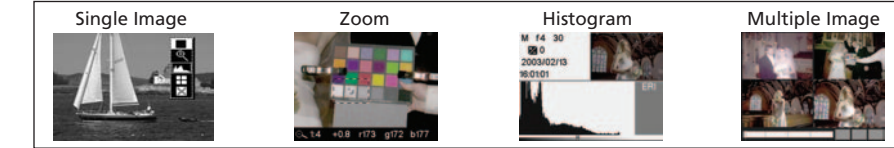

Review the Image LCD to verify images are captured correctly.

### Selecting an Image Mode

1. If the Image LCD is off, press the OK button to display images in the last-used Image mode. If the Image LCD and the menu are displayed, press the Menu button.
2. Press the top or bottom of the Four-way switch to sequence through the Image modes in the following order: Single Image, Zoom, Histogram, and Multiple Image.



### Navigating Through Images

- Press the left or right of the Four-way switch to navigate through images within a folder.  
  
In Zoom mode, press the Cancel button to disable the Region of Interest box, then navigate.

### Zooming and Panning

- In Zoom mode, press the OK button to zoom (1:4, 1:1, unzoomed 1:16).
- Press any side of the Four-way switch to pan.